

## STYLE SM

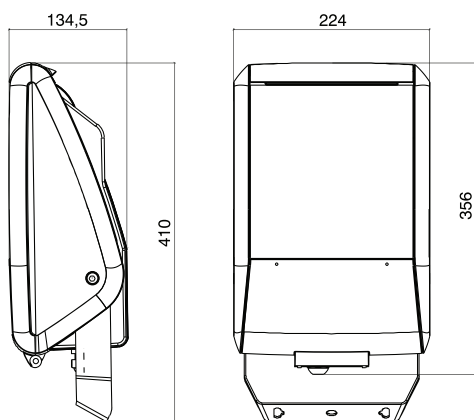

W



W	Light Distribution	Weight (kg)	Color Temperature	Product Code
500W	QT-DE /R7s/	3,40	☐	CL200001.170
500W	QT-DE /R7s/	3,40	■	CL200002.170
500W	QT-DE /R7s/	3,40	■	CL200003.170
70W	HIT-DE/HST-DE /RX7s/	4,60	☐	CL200121.170
70W	HIT-DE/HST-DE /RX7s/	4,60	■	CL200122.170
70W	HIT-DE/HST-DE /RX7s/	4,60	■	CL200123.170
150W	HIT-DE/HST-DE /RX7s/	5,50	☐	CL200121.115
150W	HIT-DE/HST-DE /RX7s/	5,50	■	CL200122.115
150W	HIT-DE/HST-DE /RX7s/	5,50	■	CL200123.115
70W	HIE/HSE /E27/	4,60	☐	CL208121.170
70W	HIE/HSE /E27/	4,60	■	CL208122.170
70W	HIE/HSE /E27/	4,60	■	CL208123.170
150W	HIE/E27/	5,50	☐	CL208121.115
150W	HIE/E27/	5,50	■	CL208122.115
150W	HIE/E27/	5,50	■	CL208123.115
70W	HIT /G12/	4,60	☐	CL206121.170
70W	HIT /G12/	4,60	■	CL206122.170
70W	HIT /G12/	4,60	■	CL206123.170
150W	HIT /G12/	5,50	☐	CL206121.115
150W	HIT /G12/	5,50	■	CL206122.115
150W	HIT /G12/	5,50	■	CL206123.115

## STYLE AS



W



W	Light Distribution	Weight (kg)	Color Temperature	Product Code
500W	QT-DE /R7s/	3,40	☐	CL202001.170
500W	QT-DE /R7s/	3,40	■	CL202002.170
500W	QT-DE /R7s/	3,40	■	CL202003.170
70W	HIT-DE/HST-DE /RX7s/	4,60	☐	CL202121.170
70W	HIT-DE/HST-DE /RX7s/	4,60	■	CL202122.170
70W	HIT-DE/HST-DE /RX7s/	4,60	■	CL202123.170
150W	HIT-DE/HST-DE /RX7s/	5,50	☐	CL202121.115
150W	HIT-DE/HST-DE /RX7s/	5,50	■	CL202122.115
150W	HIT-DE/HST-DE /RX7s/	5,50	■	CL202123.115

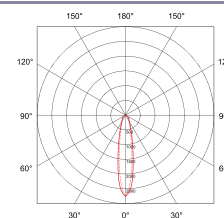

STYLE C

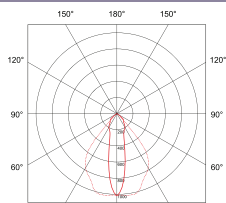

STYLE SM

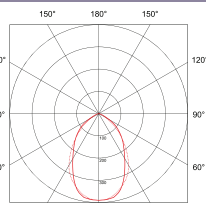

STYLE SM E27

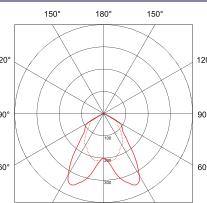

STYLE SM G12

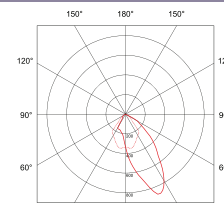

STYLE AS

W				
500W	QT-DE /R7s/	3,40	<input type="checkbox"/>	CL204001.170
500W	QT-DE /R7s/	3,40	<input checked="" type="checkbox"/>	CL204002.170
500W	QT-DE /R7s/	3,40	<input type="checkbox"/>	CL204003.170
70W	HIT-DE/HST-DE /RX7s/	4,60	<input type="checkbox"/>	CL204121.170
70W	HIT-DE/HST-DE /RX7s/	4,60	<input checked="" type="checkbox"/>	CL204122.170
70W	HIT-DE/HST-DE /RX7s/	4,60	<input type="checkbox"/>	CL204123.170
150W	HIT-DE/HST-DE /RX7s/	5,50	<input type="checkbox"/>	CL204121.115
150W	HIT-DE/HST-DE /RX7s/	5,50	<input checked="" type="checkbox"/>	CL204122.115
150W	HIT-DE/HST-DE /RX7s/	5,50	<input type="checkbox"/>	CL204123.115



AKCESORIA ■ ACCESSORIES ■ ZUBEHÖR ■ ДОПОЛНИТЕЛЬНЫЕ ЭЛЕМЕНТЫ

0,20	CL920000.000

Siatka ochronna  
Protective grid  
Schutzgitter  
Защитная сетка



AKCESORIA ■ ACCESSORIES ■ ZUBEHÖR ■ ДОПОЛНИТЕЛЬНЫЕ ЭЛЕМЕНТЫ

0,30	<input type="checkbox"/>	CL920001.002
0,30	<input checked="" type="checkbox"/>	CL920002.002
0,30	<input type="checkbox"/>	CL920003.002

Przesłona antyolśnieniowa  
Antiglare shutter  
Blendschutz  
Заслон препятствующий ослеплению



AKCESORIA ■ ACCESSORIES ■ ZUBEHÖR ■ ДОПОЛНИТЕЛЬНЫЕ ЭЛЕМЕНТЫ

1,80	<input type="checkbox"/>	CL920001.001	L=74cm
1,80	<input checked="" type="checkbox"/>	CL920002.001	L=74cm
1,80	<input type="checkbox"/>	CL920003.001	L=74cm

Uchwyt ścienny  
Wall bracket  
Wandbefestigung  
Настенное крепление



AKCESORIA ■ ACCESSORIES ■ ZUBEHÖR ■ ДОПОЛНИТЕЛЬНЫЕ ЭЛЕМЕНТЫ

1,90	<input type="checkbox"/>	CL920001.005	L=74cm
1,90	<input checked="" type="checkbox"/>	CL920002.005	L=74cm
1,90	<input type="checkbox"/>	CL920003.005	L=74cm

Uchwyt ścienny regulowany  
Adjustable wall bracket  
Regulierbar Wandbügel  
Держатель настенный регулируемый



AKCESORIA ■ ACCESSORIES ■ ZUBEHÖR ■ ДОПОЛНИТЕЛЬНЫЕ ЭЛЕМЕНТЫ

0,88	<input type="checkbox"/>	CL920003.006

Łącznik do słupa  
Pole adapter  
Mastverbinder  
Крепеж к столбу



## EVOLUTION SM



**W**



W	Beam spread	Weight (kg)	Color temperature	Product Code
250W	HIT /E40/	11,03	□	CL210231.125
250W	HIT /E40/	11,03	■	CL210232.125
250W	HIT /E40/	11,03	■	CL210233.125
400W	HIT /E40/	11,03	□	CL210231.140
400W	HIT /E40/	11,03	■	CL210232.140
400W	HIT /E40/	11,03	■	CL210233.140
250W	HIT*/E40/	9,63	□	CL210331.125
250W	HIT*/E40/	9,63	■	CL210332.125
250W	HIT*/E40/	9,63	■	CL210333.125
400W	HIT*/E40/	10,95	□	CL210331.140
400W	HIT*/E40/	10,95	■	CL210332.140
400W	HIT*/E40/	10,95	■	CL210333.140
250W	HST /E40/	11,03	□	CL210131.125
250W	HST /E40/	11,03	■	CL210132.125
250W	HST /E40/	11,03	■	CL210133.125
400W	HST /E40/	12,22	□	CL210131.140
400W	HST /E40/	12,22	■	CL210132.140
400W	HST /E40/	12,22	■	CL210133.140

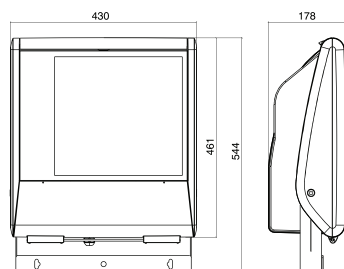

## EVOLUTION AS



**W**



W	Beam spread	Weight (kg)	Color temperature	Product Code
250W	HIT /E40/	11,03	□	CL212231.125
250W	HIT /E40/	11,03	■	CL212232.125
250W	HIT /E40/	11,03	■	CL212233.125
400W	HIT /E40/	11,23	□	CL212231.140
400W	HIT /E40/	11,23	■	CL212232.140
400W	HIT /E40/	11,23	■	CL212233.140
250W	HIT*/E40/	9,63	□	CL212331.125
250W	HIT*/E40/	9,63	■	CL212332.125
250W	HIT*/E40/	9,63	■	CL212333.125
400W	HIT*/E40/	10,95	□	CL212331.140
400W	HIT*/E40/	10,95	■	CL212332.140
400W	HIT*/E40/	10,95	■	CL212333.140
250W	HST /E40/	11,03	□	CL212131.125
250W	HST /E40/	11,03	■	CL212132.125
250W	HST /E40/	11,03	■	CL212133.125
400W	HST /E40/	12,22	□	CL212131.140
400W	HST /E40/	12,22	■	CL212132.140
400W	HST /E40/	12,22	■	CL212133.140

\*- patrz: Źródła światła  
 - see: Light sources  
 - siehe: Lichtquellen  
 - см. Источники света

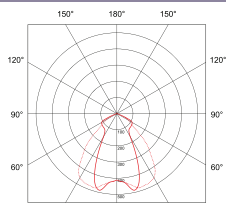

EVOLUTION SM

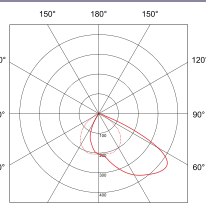

EVOLUTION AS

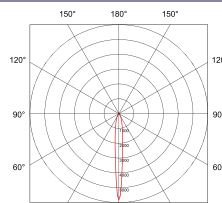

EVOLUTION C

W		kg		
250W	HIT /E40/	11,03	<input type="checkbox"/>	CL214231.125
250W	HIT /E40/	11,03	<input checked="" type="checkbox"/>	CL214232.125
250W	HIT /E40/	11,03	<input type="checkbox"/>	CL214233.125
400W	HIT /E40/	11,23	<input type="checkbox"/>	CL214231.140
400W	HIT /E40/	11,23	<input checked="" type="checkbox"/>	CL214232.140
400W	HIT /E40/	11,23	<input type="checkbox"/>	CL214233.140
250W	HIT*/E40/	9,63	<input type="checkbox"/>	CL214331.125
250W	HIT*/E40/	9,63	<input checked="" type="checkbox"/>	CL214332.125
250W	HIT*/E40/	9,63	<input type="checkbox"/>	CL214333.125
400W	HIT*/E40/	10,95	<input type="checkbox"/>	CL214331.140
400W	HIT*/E40/	10,95	<input checked="" type="checkbox"/>	CL214332.140
400W	HIT*/E40/	10,95	<input type="checkbox"/>	CL214333.140
250W	HST /E40/	11,03	<input type="checkbox"/>	CL214131.125
250W	HST /E40/	11,03	<input checked="" type="checkbox"/>	CL214132.125
250W	HST /E40/	11,03	<input type="checkbox"/>	CL214133.125
400W	HST /E40/	12,22	<input type="checkbox"/>	CL214131.140
400W	HST /E40/	12,22	<input checked="" type="checkbox"/>	CL214132.140
400W	HST /E40/	12,22	<input type="checkbox"/>	CL214133.140

**EVOLUTION C**

**AKCESORIA ■ ACCESSORIES ■ ZUBEHÖR ■ ДОПОЛНИТЕЛЬНЫЕ ЭЛЕМЕНТЫ**

0,30



CL921000.000

**Siatka ochronna**

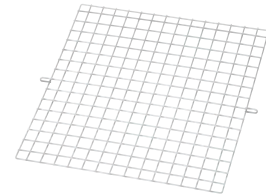
 Protective grid  
Schutzgitter  
Защитная сетка

**AKCESORIA ■ ACCESSORIES ■ ZUBEHÖR ■ ДОПОЛНИТЕЛЬНЫЕ ЭЛЕМЕНТЫ**

0,50

 CL921001.002

0,50

 CL921002.002

0,50

 CL921003.002

**Przesłona antyolśnieniowa**

 Antiglare shutter  
Blendeschutz  
Заслон, препятствующий ослеплению

**AKCESORIA ■ ACCESSORIES ■ ZUBEHÖR ■ ДОПОЛНИТЕЛЬНЫЕ ЭЛЕМЕНТЫ**

0,40

 CL921001.003

0,40

 CL921002.003

0,40

 CL921003.003

**Ogranicznik strumienia**

 Flux control visor  
Strahlbegrenzer  
Ограничитель светового потока

**AKCESORIA ■ ACCESSORIES ■ ZUBEHÖR ■ ДОПОЛНИТЕЛЬНЫЕ ЭЛЕМЕНТЫ**

1,20

 CL921003.004

**Łącznik do słupa**

 Pole adapter  
Mastverbinder  
Крепеж к столбу

CE COSMO SM



W				
250W	HIT /E40/	9,65	■	CL223232.125
250W	HIT /E40/	9,65	□	CL223233.125
400W	HIT /E40/	9,85	■	CL223232.140
400W	HIT /E40/	9,85	□	CL223233.140
250W	HIT*/E40/	8,25	■	CL223332.125
250W	HIT*/E40/	8,25	□	CL223333.125
400W	HIT*/E40/	9,57	■	CL223332.140
400W	HIT*/E40/	9,57	□	CL223333.140
250W	HST /E40/	9,65	■	CL223132.125
250W	HST /E40/	9,65	□	CL223133.125
400W	HST /E40/	10,84	■	CL223132.140
400W	HST /E40/	10,84	□	CL223133.140

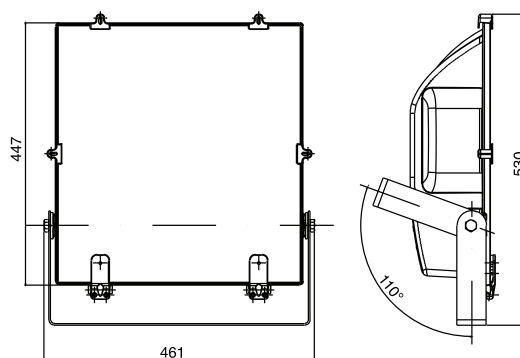

CE COSMO AS



W				
250W	HIT /E40/	9,65	■	CL224232.125
250W	HIT /E40/	9,65	□	CL224233.125
400W	HIT /E40/	9,85	■	CL224232.140
400W	HIT /E40/	9,85	□	CL224233.140
250W	HIT*/E40/	8,25	■	CL224332.125
250W	HIT*/E40/	8,25	□	CL224333.125
400W	HIT*/E40/	9,57	■	CL224332.140
400W	HIT*/E40/	9,57	□	CL224333.140
250W	HST /E40/	9,65	■	CL224132.125
250W	HST /E40/	9,65	□	CL224133.125
400W	HST /E40/	10,84	■	CL224132.140
400W	HST /E40/	10,84	□	CL224133.140



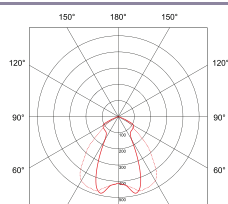

\*- patrz: Źródła światła  
 - see: Light sources  
 - siehe: Lichtquellen  
 - см. Источники света

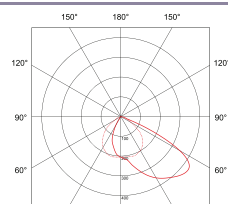

COSMO SM



COSMO AS

W				
250W	HIT /E40/	9,65	■	CL225232.125
250W	HIT /E40/	9,65	□	CL225233.125
400W	HIT /E40/	9,85	■	CL225232.140
400W	HIT /E40/	9,85	□	CL225233.140
250W	HIT*/E40/	8,25	■	CL225332.125
250W	HIT*/E40/	8,25	□	CL225333.125
400W	HIT*/E40/	9,57	■	CL225332.140
400W	HIT*/E40/	9,57	□	CL225333.140
250W	HST /E40/	9,65	■	CL225132.125
250W	HST /E40/	9,65	□	CL225133.125
400W	HST /E40/	10,84	■	CL225132.140
400W	HST /E40/	10,84	□	CL225133.140



**COSMO C**

- 
- 
- IP65**
- IK10**
- 
- 
- 
- 
- 

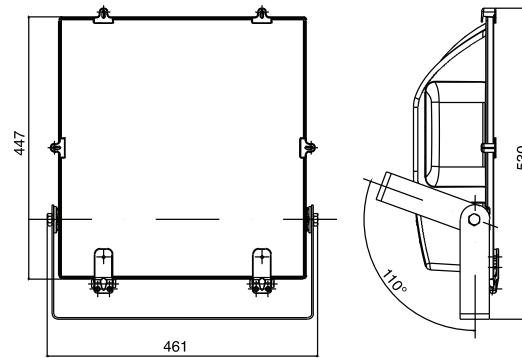

\* - patrz: Źródła światła  
 - see: Light sources  
 - siehe: Lichtquellen  
 - см. Источники света

**AKCESORIA ■ ACCESSORIES ■ ZUBEHÖR ■ ДОПОЛНИТЕЛЬНЫЕ ЭЛЕМЕНТЫ**



0,30



CL924000.000

**Siatka ochronna**

Protective grid  
 Schutzgitter  
 Защитная сетка

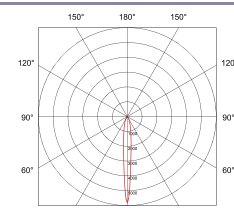
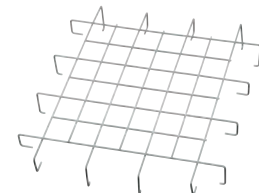

**COSMO C**

CE **START SM**



W				
1x250W	HIT/HST /E40/	10,78	<input type="checkbox"/>	CL216121.125
1x400W	HIT/HST /E40/	11,98	<input type="checkbox"/>	CL216121.140
1x250W	HIT*/E40/	9,38	<input type="checkbox"/>	CL216321.125
1x400W	HIT*/E40/	10,70	<input type="checkbox"/>	CL216321.140
1x250W	HME /E40/	9,24	<input type="checkbox"/>	CL216421.125
1x400W	HME /E40/	10,56	<input type="checkbox"/>	CL216421.140
2x250W	HIT/HST /E40/	19,11	<input type="checkbox"/>	CL216121.225
2x400W	HIT/HST /E40/	21,51	<input type="checkbox"/>	CL216121.240
2x250W	HIT*/E40/	16,31	<input type="checkbox"/>	CL216321.225
2x400W	HIT*/E40/	18,95	<input type="checkbox"/>	CL216321.240
2x250W	HME /E40/	16,03	<input type="checkbox"/>	CL216421.225
2x400W	HME /E40/	18,66	<input type="checkbox"/>	CL216421.240

START 2x...

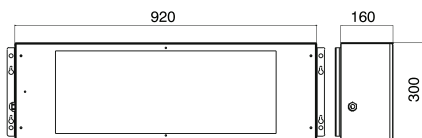

START 1x...

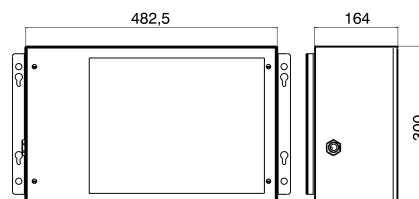

CE **START AS**



W				
1x250W	HIT/HST /E40/	10,78	<input type="checkbox"/>	CL217121.125
1x400W	HIT/HST /E40/	11,98	<input type="checkbox"/>	CL217121.140
1x250W	HIT*/E40/	9,38	<input type="checkbox"/>	CL217321.125
1x400W	HIT*/E40/	10,70	<input type="checkbox"/>	CL217321.140
1x250W	HME /E40/	9,24	<input type="checkbox"/>	CL217421.125
1x400W	HME /E40/	10,56	<input type="checkbox"/>	CL217421.140
2x250W	HIT/HST /E40/	19,11	<input type="checkbox"/>	CL217121.225
2x400W	HIT/HST /E40/	21,51	<input type="checkbox"/>	CL217121.240
2x250W	HIT*/E40/	16,31	<input type="checkbox"/>	CL217321.225
2x400W	HIT*/E40/	18,95	<input type="checkbox"/>	CL217321.240
2x250W	HME /E40/	16,03	<input type="checkbox"/>	CL217421.225
2x400W	HME /E40/	18,66	<input type="checkbox"/>	CL217421.240

\*- patrz: Źródła światła  
 - see: Light sources  
 - siehe: Lichtquellen  
 - см. Источники света

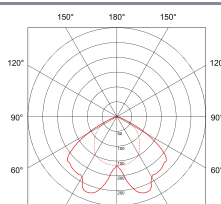

START SM 1 x

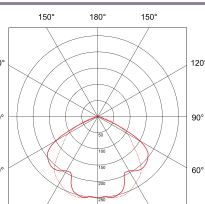

START SM 2 x

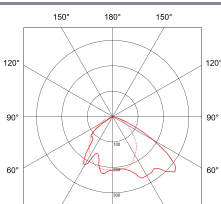

START AS 1 x

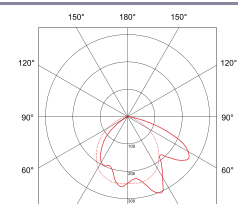

START AS 2 x

## AKCESORIA ■ ACCESSORIES ■ ZUBEHÖR ■ ДОПОЛНИТЕЛЬНЫЕ ЭЛЕМЕНТЫ



0,20	CL921600.003	1 x ...
0,30	CL921600.004	2 x ...

**Siatka ochronna**

Protective grid  
Schutzgitter  
Защитная сетка

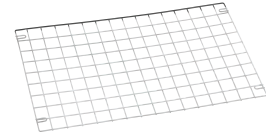

## AKCESORIA ■ ACCESSORIES ■ ZUBEHÖR ■ ДОПОЛНИТЕЛЬНЫЕ ЭЛЕМЕНТЫ



1,20	<input type="checkbox"/>	CL921601.000	1 x ...
2,40	<input type="checkbox"/>	CL921601.002	2 x ...

**Uchwyt ścienny obrotowy**

Rotating wall bracket  
Drehwandbefestigung  
Настенное крепление



## AKCESORIA ■ ACCESSORIES ■ ZUBEHÖR ■ ДОПОЛНИТЕЛЬНЫЕ ЭЛЕМЕНТЫ



1,60	<input type="checkbox"/>	CL921601.001
------	--------------------------	--------------

**Ramka do wbudowania 1x...**

Frame for building-in 1x...  
Rahmen zum Einbauen 1x...  
Рамка для встраивания 1x...



CE JET SM



1000W	HST /E40/	20,60	■	NAV-T 10,3A	FA52773
1000W	HIT /E40/	20,60	■	HQI-T 9,5A	FA50694
1000W	HIT /E40/	17,73	■	HPI-T 8,2A	FA50571
2000W	HIT /E40/	32,60	■	HQI-T/D/I 10,3A	FA50603

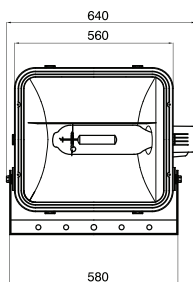

JET 2000 W SM

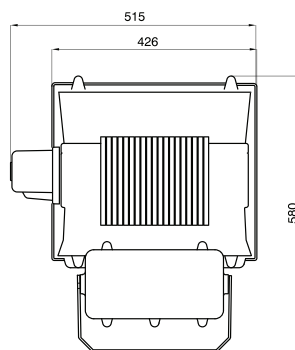
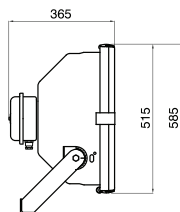

JET 1000 W SM

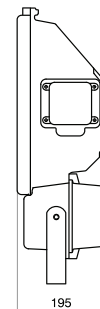

CE JET AS



1000W	HST /E40/	28,70	■	NAV-T 10,3A	FA50704
1000W	HIT /E40/	28,70	■	HQI-T 9,5A	FA50698
1000W	HIT /E40/	27,35	■	HPI-T 8,2A	FA50615
2000W	HIT /E40/	33,60	■	HQI-T/D/I 10,3A	FA50611

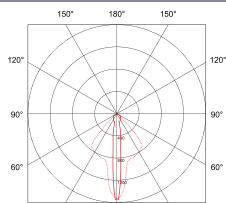
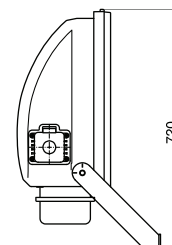
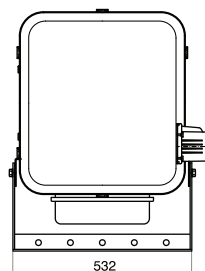

JET SM 1000W

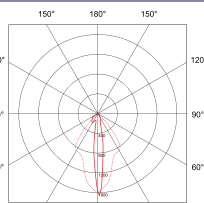

JET SM 2000W

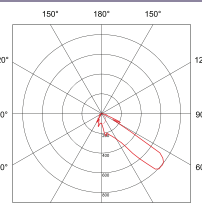

JET AS 1000W

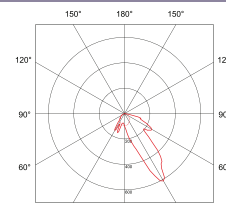

JET AS 2000W

# LIGHTMASTER C



W	Icon	kg	Color	!	Icon
1000W	HST /E40/	30,90	Grey	NAV-T 10,3A	FALM1S
1000W	HIT /E40/	38,60	Grey	HQI-T 9,5A	FALM1O
1000W	HIT /E40/	30,90	Grey	HPI-T 8,2A	FALM1P
2000W	HIT-DE /-/	38,60	Grey	HQI-TS 2000/D/S	FALM2O

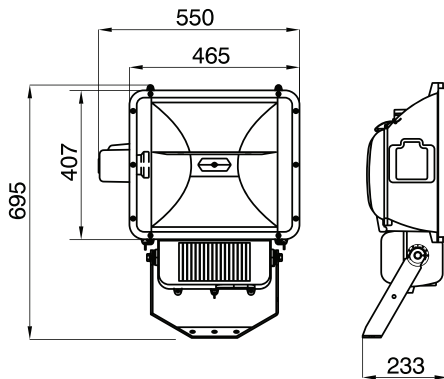

LIGHTMASTER C 1000 W

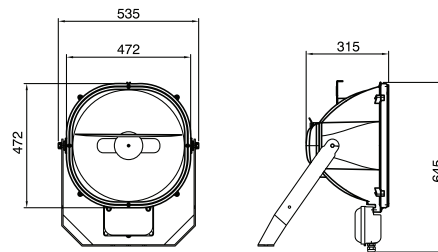

LIGHTMASTER C 2000 W

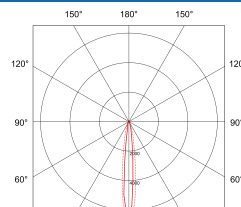

LIGHTMASTER 1000W

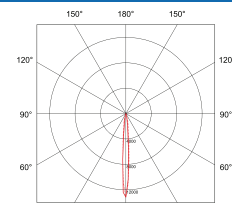

LIGHTMASTER 2000W