

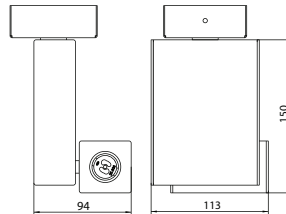

**RAY**

z bazą mocującą  
with bracket  
mit Befestigungsplatte  
с креплением



W		kg		!	
35W	CDM-R111/GX8.5/	1,20	<input type="checkbox"/>	EVG	PX1010401
70W	CDM-R111/GX8.5/	1,20	<input type="checkbox"/>	EVG	PX1010405
100W	QR111/G53/	0,90	<input type="checkbox"/>		PX1010409

z adaptorem 3-fazowym  
with 3-phase adapter  
mit 3-Phasen Adapter  
с 3-фазовым адаптером

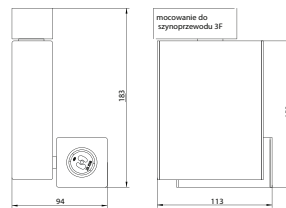

W		kg		!	
35W	CDM-R111/GX8.5/	1,20	<input type="checkbox"/>	EVG	PX1010095
70W	CDM-R111/GX8.5/	1,20	<input type="checkbox"/>	EVG	PX1010101
100W	QR111 /G53/	0,90	<input type="checkbox"/>		PX1010301



POP LED

RAY

NICE

NICE LED



**POP LED**  
 z adaptorem 3-fazowym  
 with 3-phase adapter  
 mit 3-Phasen Adapter  
 с 3-фазовым адаптером

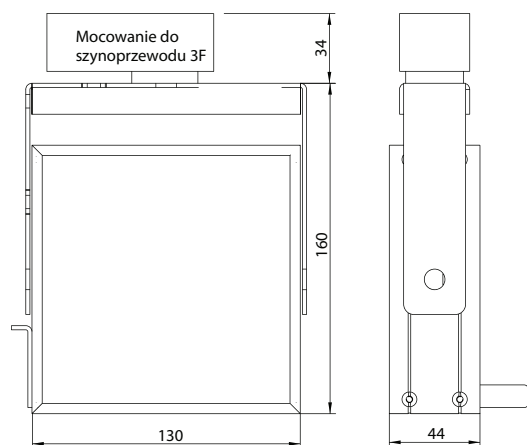

**W**

20W



5 x LED



0,90



■



PXF  
0123456  
PX0863901



MERLINO 110

STAGE 700

MINISEVEN

SEVEN



NICE

W	Icon	kg	Color	PXF 0123456		W	Icon	kg	Color	PXF 0123456	!		
300W	QT-DE 12 /R7s/	2,00	□	CL400001.170	NICE TS	75W	PAR 30 /E27/	2,00	□	CL403941.175	*	NICE PAR	
300W	QT-DE 12 /R7s/	2,00	■	CL400002.170		75W	PAR 30 /E27/	2,00	■	CL403942.175	*		
300W	QT-DE 12 /R7s/	2,00	■	CL400003.170		75W	PAR 30 /E27/	2,00	■	CL403943.175	*		
70W	HIT-DE /RX7s/	3,20	□	CL400221.170		100W	PAR 30 /E27/	2,00	□	CL403941.110	*		
70W	HIT-DE /RX7s/	3,20	■	CL400222.170		100W	PAR 30 /E27/	2,00	■	CL403942.110	*		
70W	HIT-DE /RX7s/	3,20	■	CL400223.170		100W	PAR 30 /E27/	2,00	■	CL403943.110	*		
150W	HIT-DE /RX7s-24/	4,00	□	CL400221.115		75W	QR 111 /G53/	2,00	□	CL404941.175	*	NICE SPOT	
150W	HIT-DE /RX7s-24/	4,00	■	CL400222.115		75W	QR 111 /G53/	2,00	■	CL404942.175	*		
150W	HIT-DE /RX7s-24/	4,00	■	CL400223.115		75W	QR 111 /G53/	2,00	■	CL404943.175	*		
70W	HIT/HIT-CRI /G12/	3,20	□	CL402221.170		100W	QR 111 /G53/	2,00	□	CL404941.110	*		
70W	HIT/HIT-CRI /G12/	3,20	■	CL402222.170		100W	QR 111 /G53/	2,00	■	CL404942.110	*		
70W	HIT/HIT-CRI /G12/	3,20	■	CL402223.170		100W	QR 111 /G53/	2,00	■	CL404943.110	*		
150W	HIT/HIT-CRI /G12/	4,00	□	CL402221.115									
150W	HIT/HIT-CRI /G12/	4,00	■	CL402222.115									
150W	HIT/HIT-CRI /G12/	4,00	■	CL402223.115									

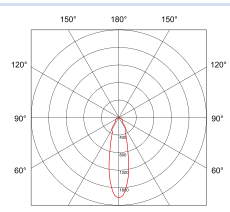

NICE PAR 75 W

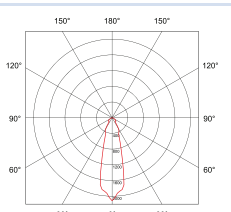

NICE PAR 100 W

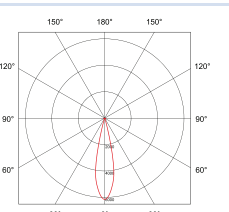

NICE SPOT 75 W

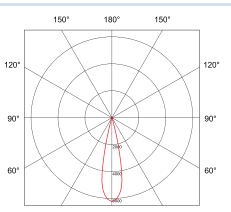

NICE SPOT 100 W

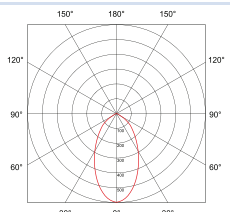



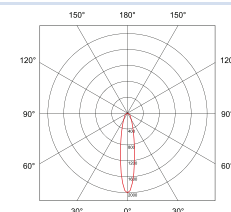

NICE TS



NICE MASTERCOLOR





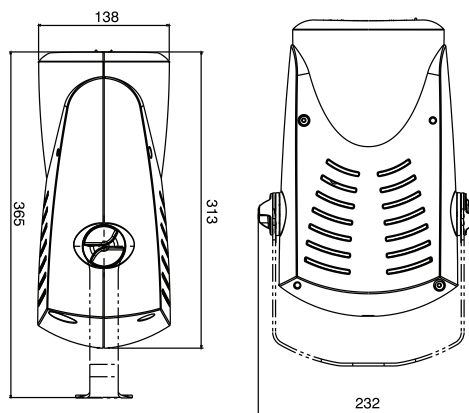

NICE LED

W					!
18W	5x LED RGB	3,15	<input type="checkbox"/>	CL406641.535M	350 Lm/ 36°
18W	5x LED RGB	3,15	<input checked="" type="checkbox"/>	CL406642.535M	350 Lm/ 36°
18W	5x LED RGB	3,15	<input type="checkbox"/>	CL406643.535M	350 Lm/ 36°
19W	7x POWER LED	2,95	<input type="checkbox"/>	CL406641.713M	890 Lm/ 3500K/ 36°
19W	7x POWER LED	2,95	<input checked="" type="checkbox"/>	CL406642.713M	890 Lm/ 3500K/ 36°
19W	7x POWER LED	2,95	<input type="checkbox"/>	CL406643.713M	890 Lm/ 3500K/ 36°
19W	7x POWER LED	2,95	<input type="checkbox"/>	CL406641.714M	890 Lm/ 6000K/ 36°
19W	7x POWER LED	2,95	<input checked="" type="checkbox"/>	CL406642.714M	890 Lm/ 6000K/ 36°
19W	7x POWER LED	2,95	<input type="checkbox"/>	CL406643.714M	890 Lm/ 6000K/ 36°
19W	7x POWER LED	2,95	<input type="checkbox"/>	CL406641.716M	1100 Lm/ 6000K/ 36°
19W	7x POWER LED	2,95	<input checked="" type="checkbox"/>	CL406642.716M	1100 Lm/ 6000K/ 36°
19W	7x POWER LED	2,95	<input type="checkbox"/>	CL406643.716M	1100 Lm/ 6000K/ 36°



NICE, NICE LED

	<p style="text-align: center;">AKCESORIA ■ ACCESSORIES ■ ZUBENÖR ■ ДОПОЛНИТЕЛЬНЫЕ ЭЛЕМЕНТЫ</p> <p><b>Adaptor elektryczny (5kg/6A)</b> Electrical adapter (5kg/6A) Elektrischer Adapter (5Kg/6A) Электрический адаптер (5кг/6A)</p> <p><b>Adaptor mechaniczny*</b> Mechanical adapter (5kg/6A) Mechanischer Adapter (5Kg/6A) Механический адаптер (5кг/6A)</p> <table border="1"> <thead> <tr> <th>kg</th> <th>Color</th> <th>Code</th> </tr> </thead> <tbody> <tr> <td>0,07</td> <td>White</td> <td>IV7601-00-W31</td> </tr> <tr> <td>0,07</td> <td>Black</td> <td>IV7601-00-W30</td> </tr> <tr> <td>0,07</td> <td>Grey</td> <td>IV7601-00-W20</td> </tr> <tr> <td>0,08</td> <td>White</td> <td>IV7625-00-31</td> </tr> <tr> <td>0,08</td> <td>Black</td> <td>IV7625-00-30</td> </tr> <tr> <td>0,08</td> <td>Grey</td> <td>IV7625-00-52</td> </tr> </tbody> </table>	kg	Color	Code	0,07	White	IV7601-00-W31	0,07	Black	IV7601-00-W30	0,07	Grey	IV7601-00-W20	0,08	White	IV7625-00-31	0,08	Black	IV7625-00-30	0,08	Grey	IV7625-00-52
kg	Color	Code																				
0,07	White	IV7601-00-W31																				
0,07	Black	IV7601-00-W30																				
0,07	Grey	IV7601-00-W20																				
0,08	White	IV7625-00-31																				
0,08	Black	IV7625-00-30																				
0,08	Grey	IV7625-00-52																				
	<p style="text-align: center;">AKCESORIA ■ ACCESSORIES ■ ZUBENÖR ■ ДОПОЛНИТЕЛЬНЫЕ ЭЛЕМЕНТЫ</p> <p><b>Adaptor elektryczny (10kg/6A)</b> Electrical adapter (10kg/6A) Elektrischer Adapter (10Kg/6A) Электрический адаптер (10кг/6A)</p> <table border="1"> <thead> <tr> <th>kg</th> <th>Color</th> <th>Code</th> </tr> </thead> <tbody> <tr> <td>0,07</td> <td>White</td> <td>IV7600-00-31</td> </tr> <tr> <td>0,07</td> <td>Black</td> <td>IV7600-00-30</td> </tr> <tr> <td>0,07</td> <td>Grey</td> <td>IV7600-00-20</td> </tr> </tbody> </table>	kg	Color	Code	0,07	White	IV7600-00-31	0,07	Black	IV7600-00-30	0,07	Grey	IV7600-00-20									
kg	Color	Code																				
0,07	White	IV7600-00-31																				
0,07	Black	IV7600-00-30																				
0,07	Grey	IV7600-00-20																				
	<p style="text-align: center;">AKCESORIA ■ ACCESSORIES ■ ZUBENÖR ■ ДОПОЛНИТЕЛЬНЫЕ ЭЛЕМЕНТЫ</p> <p><b>Baza mocująca</b> Wall joint Wandverbinder Настенный соединитель</p> <table border="1"> <thead> <tr> <th>kg</th> <th>Color</th> <th>Code</th> </tr> </thead> <tbody> <tr> <td>0,14</td> <td>White</td> <td>CL940001.001</td> </tr> <tr> <td>0,14</td> <td>Black</td> <td>CL940002.001</td> </tr> <tr> <td>0,14</td> <td>Grey</td> <td>CL940003.001</td> </tr> </tbody> </table>	kg	Color	Code	0,14	White	CL940001.001	0,14	Black	CL940002.001	0,14	Grey	CL940003.001									
kg	Color	Code																				
0,14	White	CL940001.001																				
0,14	Black	CL940002.001																				
0,14	Grey	CL940003.001																				
	<p style="text-align: center;">AKCESORIA ■ ACCESSORIES ■ ZUBENÖR ■ ДОПОЛНИТЕЛЬНЫЕ ЭЛЕМЕНТЫ</p> <p><b>Klapka antyolśnieniowa</b> Antiglare shutter Blendschutz Прикрытие, препятствующее ослеплению</p> <table border="1"> <thead> <tr> <th>kg</th> <th>Color</th> <th>Code</th> </tr> </thead> <tbody> <tr> <td>0,20</td> <td>White</td> <td>CL940001.003</td> </tr> <tr> <td>0,20</td> <td>Black</td> <td>CL940002.003</td> </tr> <tr> <td>0,20</td> <td>Grey</td> <td>CL940003.003</td> </tr> </tbody> </table>	kg	Color	Code	0,20	White	CL940001.003	0,20	Black	CL940002.003	0,20	Grey	CL940003.003									
kg	Color	Code																				
0,20	White	CL940001.003																				
0,20	Black	CL940002.003																				
0,20	Grey	CL940003.003																				
	<p style="text-align: center;">AKCESORIA ■ ACCESSORIES ■ ZUBENÖR ■ ДОПОЛНИТЕЛЬНЫЕ ЭЛЕМЕНТЫ</p> <p><b>Zawieszenie</b> suspension Aufhängung подвес</p> <table border="1"> <thead> <tr> <th>kg</th> <th>Color</th> <th>Code</th> </tr> </thead> <tbody> <tr> <td>0,20</td> <td>White</td> <td>CL940001.002</td> </tr> <tr> <td>0,20</td> <td>Black</td> <td>CL940002.002</td> </tr> <tr> <td>0,20</td> <td>Grey</td> <td>CL940003.002</td> </tr> </tbody> </table>	kg	Color	Code	0,20	White	CL940001.002	0,20	Black	CL940002.002	0,20	Grey	CL940003.002									
kg	Color	Code																				
0,20	White	CL940001.002																				
0,20	Black	CL940002.002																				
0,20	Grey	CL940003.002																				

- W celu zamontowania oprawy NICE do szynoprzewodu należy zamówić komplet adaptorów (mechaniczno-elektryczny i mechaniczny)

- In order to install luminaire NICE on a track it is necessary to order set of adapters (mechanical-electrical and mechanical)

- Im Zweck der Leuchtenmontage NICE an Stromschiene ist nötig, den Adaptersset zu bestellen (mechanisch-elektrischer und mechanischer)

- Для установки прожектора NICE на шинопровод следует заказать комплект адаптеров (механическо-электрический и механический)



z adaptorem 3-fazowym  
 with 3-phase adapter  
 mit 3-Phasen Adapter  
 с 3-фазовым адаптером

**MERLINO 150**

**MERLINO 110**

W		kg		
70W	HIT /G12/	1,70	<input type="checkbox"/>	IV790-112-21
70W	HIT /G12/	1,70	<input type="checkbox"/>	IV790-112-52
150W	HIT /G12/	1,70	<input type="checkbox"/>	IV790-212-21
150W	HIT /G12/	1,70	<input type="checkbox"/>	IV790-212-52
70W	CDM-R111 /GX8,5/	1,70	<input type="checkbox"/>	IV790-312-21
70W	CDM-R111 /GX8,5/	1,70	<input type="checkbox"/>	IV790-312-52
100W	QR111 /G53/	1,70	<input type="checkbox"/>	IV790-512-21
100W	QR111 /G53/	1,70	<input type="checkbox"/>	IV790-512-52

W		kg		
70W	CDM-TC /G8,5/	1,00	<input type="checkbox"/>	IV791-112-21
70W	CDM-TC /G8,5/	1,00	<input type="checkbox"/>	IV791-112-52
50W	QR-CBC 51 /GU5,3/	0,80	<input type="checkbox"/>	IV792-212-21
50W	QR-CBC 51 /GU5,3/	0,80	<input type="checkbox"/>	IV792-212-52
35W	CDM-TC /G8,5/	0,80	<input type="checkbox"/>	IV792-112-21
35W	CDM-TC /G8,5/	0,80	<input type="checkbox"/>	IV792-112-52

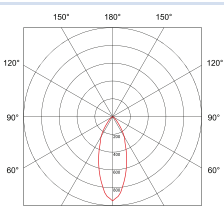
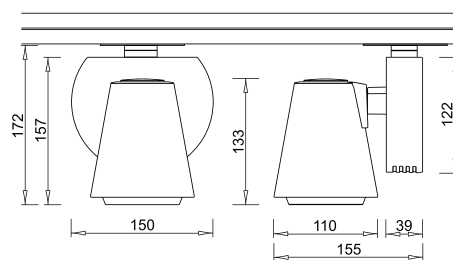
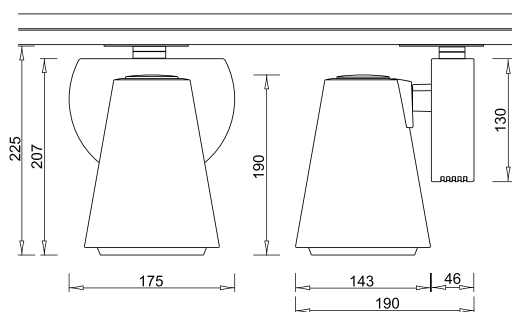

MERLINO 150 39°

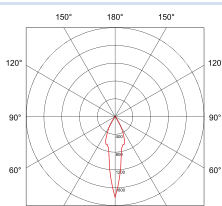

MERLINO 150 18°

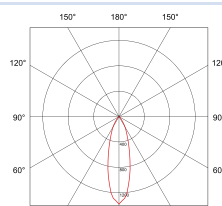

MERLINO 110 29°

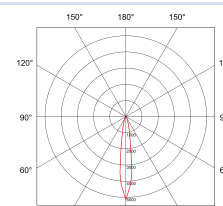

MERLINO 110 15°

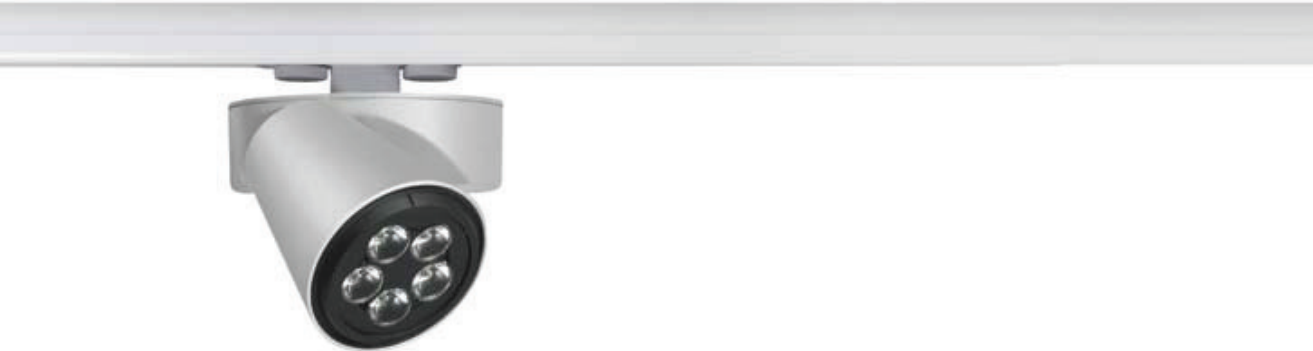

## MERLINO 90

z adaptorem 3-fazowym  
with 3-phase adapter  
mit 3-Phasen Adapter  
с 3-фазовым адаптером

W				
5W	5xLED <input type="checkbox"/>	0,60	<input type="checkbox"/>	IV793-011-21
5W	5xLED <input type="checkbox"/>	0,60	<input type="checkbox"/>	IV793-011-52

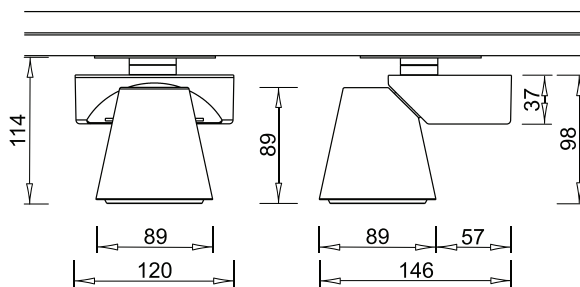

### AKCESORIA ■ ACCESSORIES ■ ZUBEHÖR ■ ДОПОЛНИТЕЛЬНЫЕ ЭЛЕМЕНТЫ



Układ optyczny  
Optic device  
Optisches System  
Оптическая система



0,05	<b>IV28-0880</b>	MERLINO 150 70W, 150W G12 (40°)
0,05	<b>IV28-0881</b>	MERLINO 110 35W, G8,5 (28°)
0,05	<b>IV28-0882</b>	MERLINO 110 70W G8,5 (29°)



**STAGE 700**

z adaptorem 3-fazowym  
 with 3-phase adapter  
 mit 3-Phasen Adapter  
 с 3-фазовым адаптером

W				
70W	HIT-DE /RX7s/	4,20		IV700-162-21
70W	HIT-DE /RX7s/	4,20		IV700-162-16
70W	HIT-DE /RX7s/	4,20		IV700-162-52
150W	HIT-DE /RX7s-24/	4,20		IV700-262-21
150W	HIT-DE /RX7s-24/	4,20		IV700-262-16
150W	HIT-DE /RX7s-24/	4,20		IV700-262-52

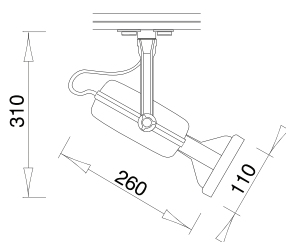

W				
70W	HIT-DE /RX7s/	3,60		IV700-122-21
70W	HIT-DE /RX7s/	3,60		IV700-122-16
70W	HIT-DE /RX7s/	3,60		IV700-122-52
150W	HIT-DE /RX7s-24/	3,60		IV700-222-21
150W	HIT-DE /RX7s-24/	3,60		IV700-222-16
150W	HIT-DE /RX7s-24/	3,60		IV700-222-52

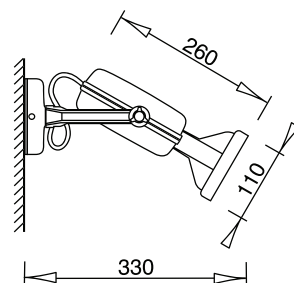

z bazą mocującą  
 with bracket  
 mit Befestigungsplatte  
 с креплением

**AKCESORIA ■ ACCESSORIES ■ ZUBEHÖR ■ ДОПОЛНИТЕЛЬНЫЕ ЭЛЕМЕНТЫ**

0,25		IV7627-00-21
0,25		IV7627-00-16
0,25		IV7627-00-52

**Klapka antyolśnieniowa**

Antiglare shutter  
 Blendschutz

Прикрытие, препятствующее ослеплению

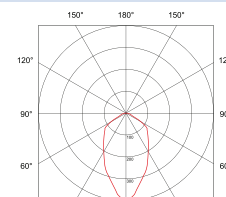

STAGE 700 150 W

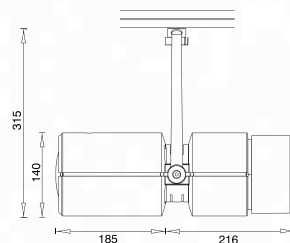

SEVEN G12

SEVEN

z adaptorem 3-fazowym  
with 3-phase adapter  
mit 3-Phasen Adapter  
с 3-фазовым адаптером

W				
70W	HIT/G12/	4,20	<input type="checkbox"/>	IV731-162-21
70W	HIT/G12/	4,20	<input type="checkbox"/>	IV731-162-52
150W	HIT/G12/	5,00	<input type="checkbox"/>	IV731-262-21
150W	HIT/G12/	5,00	<input type="checkbox"/>	IV731-262-52
70W	CDM-R 111/ GX8,5/	1,90	<input type="checkbox"/>	IV733-162-21
70W	CDM-R 111/ GX8,5/	1,90	<input type="checkbox"/>	IV733-162-52
70W	HI-PAR 30 /E27/	1,90	<input type="checkbox"/>	IV733-262-21
70W	HI-PAR 30 /E27/	1,90	<input type="checkbox"/>	IV733-262-52
100W	QR111 /G53/	1,80	<input type="checkbox"/>	IV733-462-21
100W	QR111 /G53/	1,80	<input type="checkbox"/>	IV733-462-52

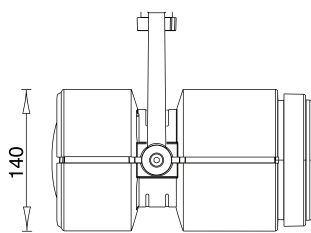

SEVEN GX8,5/E27/G53

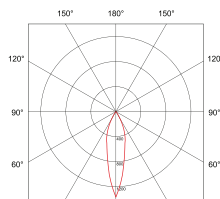

SEVEN 70W

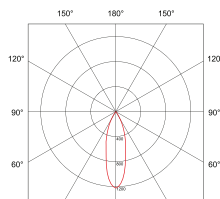

SEVEN 150W

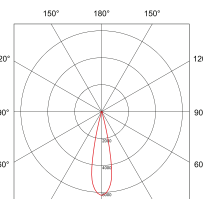

SEVEN 70W 24°

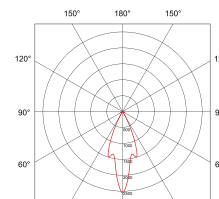

SEVEN 150W 45°

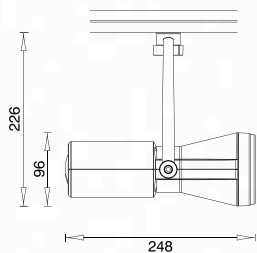

## MINISEVEN

z adaptorem 3-fazowym  
 with 3-phase adapter  
 mit 3-Phasen Adapter  
 с 3-фазовым адаптером

W				
35W	CDM-TC /G8,5/	1,00	<input type="checkbox"/>	IV736-262-21
35W	CDM-TC /G8,5/	1,00	<input type="checkbox"/>	IV736-262-52
50W	QR-CBC51/GU5,3/	1,00	<input type="checkbox"/>	IV736-360-21
50W	QR-CBC51/GU5,3/	1,00	<input type="checkbox"/>	IV736-360-52

Baza mocująca – na zapytanie  
 Wall joint – on request  
 Befestigungsplatte – auf Anfrage  
 Настенный крепеж – по запросу

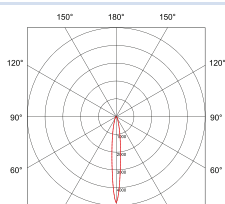

MINISEVEN 35W 12°

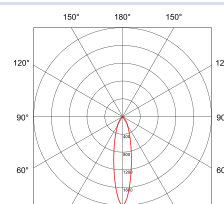

MINISEVEN 35W 23°

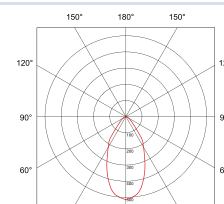

MINISEVEN 35W 51°

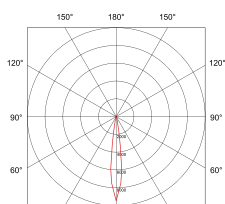

MINISEVEN 50W 10°

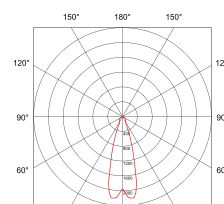

MINISEVEN 50W 38°

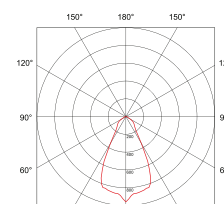



MINISEVEN 50W 60°

AKCESORIA ■ ACCESSORIES ■ ZUBEHÖR ■ ДОПОЛНИТЕЛЬНЫЕ ЭЛЕМЕНТЫ





**MINISEVEN układ optyczny 23°**  
MINISEVEN optic device 23°  
MINISEVEN optisches System 23  
MINISEVEN оптическая система 23

   
 **IV28-0860-21**  
 **IV28-0860-52**

AKCESORIA ■ ACCESSORIES ■ ZUBEHÖR ■ ДОПОЛНИТЕЛЬНЫЕ ЭЛЕМЕНТЫ





**MINISEVEN układ optyczny 51°**  
MINISEVEN optic device 51°  
MINISEVEN optisches System 51°  
MINISEVEN оптическая система 51°

   
 **IV28-0861-21**  
 **IV28-0861-52**

AKCESORIA ■ ACCESSORIES ■ ZUBEHÖR ■ ДОПОЛНИТЕЛЬНЫЕ ЭЛЕМЕНТЫ





**Zawieszenie - MINISEVEN**  
Suspension - MINISEVEN  
Die Aufhebung - MINISEVEN  
Вешание - MINISEVEN

   
 **IV7372-00-21**  
 **IV7372-00-52**

AKCESORIA ■ ACCESSORIES ■ ZUBEHÖR ■ ДОПОЛНИТЕЛЬНЫЕ ЭЛЕМЕНТЫ





**Zestaw optyczny - SEVEN 70W/150W G12**  
Optical set - SEVEN 70W/ 150W G 12  
Der optische Satz - SEVEN 70W/ 150W G 12  
Оптический набор - SEVEN 70W/ 150W G 12

   
 **IV7370-00-21**  
 **IV7370-00-52**

AKCESORIA ■ ACCESSORIES ■ ZUBEHÖR ■ ДОПОЛНИТЕЛЬНЫЕ ЭЛЕМЕНТЫ



**Zawieszenie - SEVEN**  
Suspension - SEVEN  
Die Aufhebung - SEVEN  
Вешание - SEVEN

   
 **IV7371-00-21**  
 **IV7371-00-52**

AKCESORIA ■ ACCESSORIES ■ ZUBEHÖR ■ ДОПОЛНИТЕЛЬНЫЕ ЭЛЕМЕНТЫ

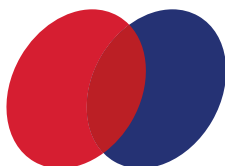

**SEVEN filtry (niebieski i czerwony)**  
SEVEN filters (blue and red)  
SEVEN die Filter (blau und rot)  
SEVEN фильтры (голубой и красный)

  
**IV160990**